



4701

hand-drawn

for light and medium-weight curtains

Rectangular and sleek

4701



hand-drawn

for light and medium-weight curtains

Rectangular and sleek

The Qurails 4701 track is a pretty rectangular profile. It is also frequently fitted in a channel cut into a wooden mounting surface. An attractive, sleek track that can be used in your home or office building.

- The ideal track for sheers and lightweight or medium-heavy curtains.
- Easy to bend and exceptional quality.
- Can be forward or reverse bent in different radii.
- Ceiling mounting invisibly or by using a metal fixing bracket.
- Compatible with the Qurails Flow System for regularly pleated curtains.
- Silent and smooth running, also round bends.



Standard colours

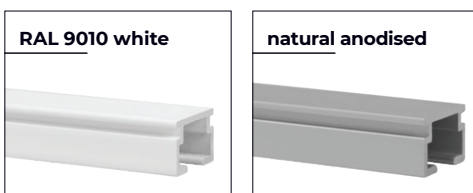

High quality, wear-resistant coating, highly colourfast, UV-resistant. Other RAL colours & special coatings on request.

Features

Material:	aluminium
Colour:	white, natural anodised
Afmetingen:	10 x 15 mm
Weight profile:	137 gr/m ¹
Mounting:	ceiling



Profile specifications

Aluminium profile:

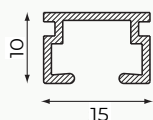

Colours with RAL code and lengths (m):

4701 and 4701-PB PB with punch type 'B':

	RAL	4	5	6	7
white	9010			•	
natural				•	

Other punch types or colours on request.

Mounting surface:

- wood
- masonry/concrete

Bracket type:

- ceiling bracket

Bending:

bending radius	bending tool
R 10 cm	1012
R 10 cm	1015
R > 80 cm	1018

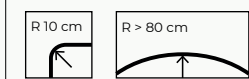

Flow

The Qurails Flow System keeps pleats in curtains consistent. It can be used with small and wide channel tracks and, because of the broad assortment of components, it can be integrated in hand-drawn, cord-pulled and electrically operated systems.

The Flow System can also be used with curved curtain tracks. For further information, see the Flow product data sheet.

Specification guide

Material

- Aluminium EN AW-6060-T66.
- Anodised in accordance with the Qualanod standard.
- Powder coated in accordance with the Qualicoat standard.

Mounting

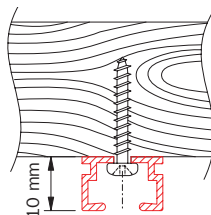

Pre-punched track from the 4700 series mounted using cross-head screws 2314

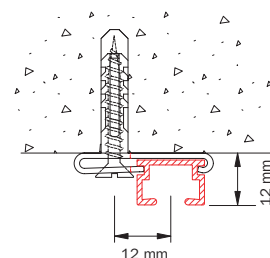

4700 mounted with ceiling bracket 4750 and a standard wood screw.

Punch types

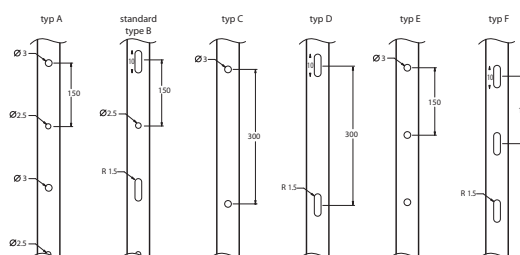

Additional mounting options

Standard punched hole type B. (Ø2.5 + 3 x 10 mm slot, every 15 cm)
Other punch types are available on request.

Application example

4701 with end cap 4753-12

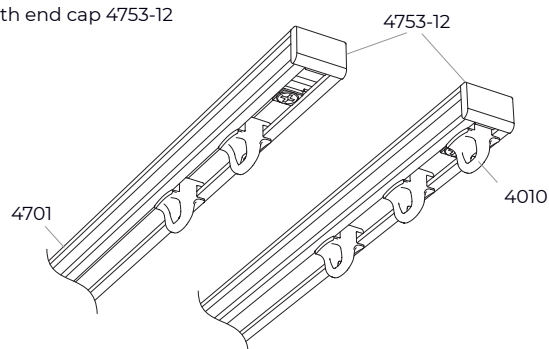

Application of the 4753-12, a product with two functions: only as end cap or as end cap and end stop.

Mounting guideline

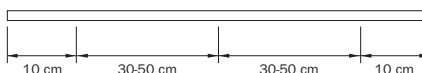

The distance between the brackets can vary depending on the following factors: the mounting surface (wood, concrete or plaster), the weight of the curtains and the curtain fabric production method, the specific application and the system usage intensity. General advice: with the curtains open, place additional brackets where the pleats bunch together. Also place additional brackets before and after bends.



Standard parts

Curtain transport



4001
end stop
white / grey / black

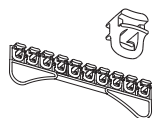

4010
glider
white / grey / black

Mounting

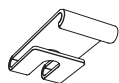

4750
ceiling bracket
white / natural

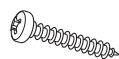

2314
Pozi-drive screw
for ceiling fixing 19
mm white / natural
metallic / black

Accessories



4753-12
end cap
white / grey

Optional parts

Curtain transport

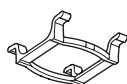

2004
brake glider
white / grey / black



4001
end stop metal
with eye natural



4002
end stop metal



4003
spring stop plastic
requires punch hole
white



4007
rotating glider white/
grey / silver / black



4007-LRS
rotating glider LRS
grijs / rotating glider
LRS red



4010-50
glider white with
hook 2023



4012
click-in glider white

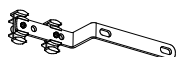

4074-1000
carrier with overlap,
a.o. for draw rod
white / natural
metallic / black

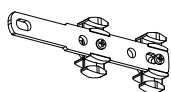

4075-1000
carrier without
overlap, a.o. for
draw rod white /
natural metallic /
black



2020
double hook
white



2021
G-Hook
white



2022
curtain hook
white



2023
curtain hook
white



2024-55
adjustable sew
in hook white
55mm



2024-95
adjustable sew
in hook white
95mm

Accessories



4048-08MM
corner
connection



7399
plexiglass
draw rod
transparent

Technical specifications are subject to change without prior notice.